

PS8-PRO CONNECTION GUIDE

Mounting the PS8-Pro-

To mount the PS8-Pro correctly in your installation you will need to follow these steps-

- 1) Using a M2.5 Allen head tool or screw driver remove the four M2.5 x 8mm socket head screws to release the acrylic PS8-Pro top illuminated display.
- 2) Carefully disconnect the displays ribbon cable from the main unit and set the display aside in a safe place.
- 3) Lift off and remove the PS8-Pro's top cosmetic cover to expose the four screw hole mounting points on the unit's main case.
- 4) Once installed, mounted and with all cables connected place the cosmetic cover back on the main unit case.
- 5) Reconnect the display ribbon cable to the PCB making sure to place careful attention to the alignment guides on the plug as it only goes into the plug socket one way. Forcing the plug into the socket incorrectly can cause permanent damage and will void the processors warranty.
- 6) Place the illuminated display back over the center opening, align the screw holes with the screw inserts on the main chassis and screws in and tighten the screws carefully making sure to not pinch the ribbon cable between the display and the case. (Note: Do not overtighten as this can cause the acrylic display to crack)

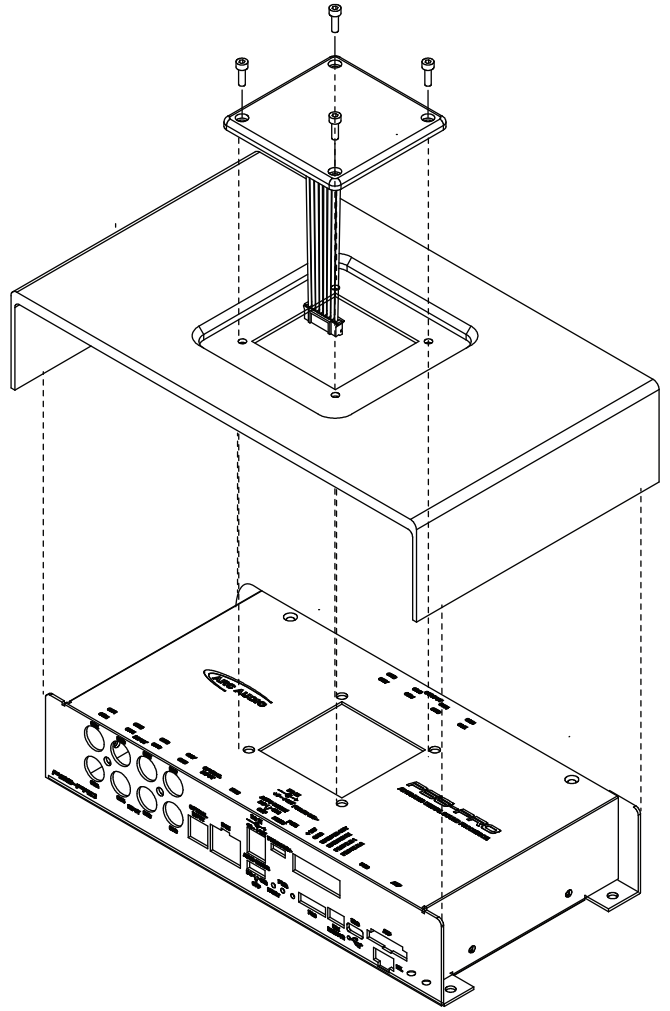

Connecting your PS8-Pro

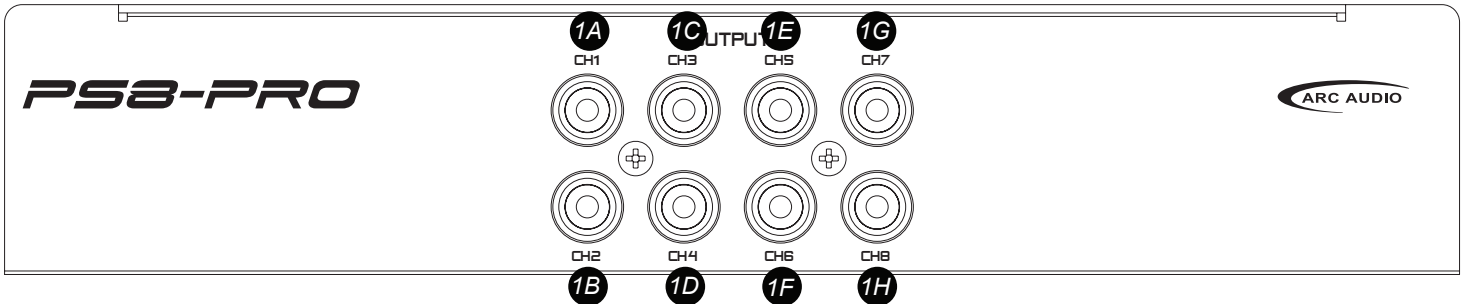

1 RCA SIGNAL OUTPUT CONNECTION

The PS8-Pro has 8-Channels of RCA output allowing you to connect your ARC Audio amplifiers RCA signal inputs. Each output is capable of signal levels of up to 8 volts and signal output assignment is done through the mixer panel in the Pro-Series user software.

- 1A - RCA Channel 1 Output
- 1B - RCA Channel 2 Output
- 1C - RCA Channel 3 Output
- 1D - RCA Channel 4 Output
- 1E - RCA Channel 5 Output
- 1F - RCA Channel 6 Output
- 1G - RCA Channel 7 Output
- 1H - RCA Channel 8 Output

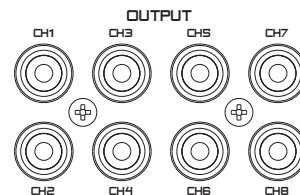

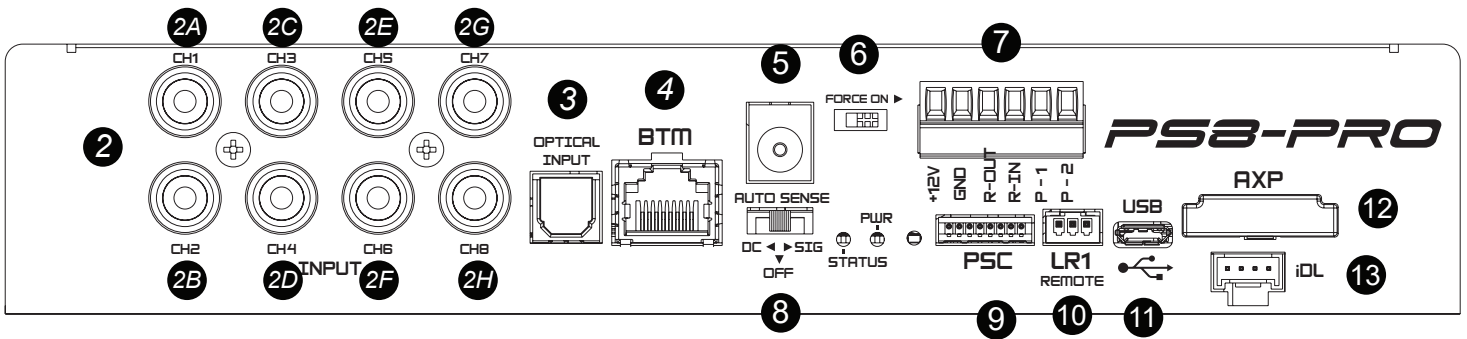

2 RCA STYPE SIGNAL INPUT CONNECTORS-

The PS8-Pro is equipped with 8 RCA style input signal connectors to connect signal source cables from your systems source unit. These inputs can accept low level signals like that found in most aftermarket source units. To connect your Low Level RCA signal cables simply plug the source unit RCA channel into the coorresponding input channel of your choice. These inputs can also accept hi-level (speaker level) signals from most OEM source units. If you are using an OEM source units be sure to measure your factory radios signal level and adjust the input sensitivity accordingly in the software utility.

- 2A- CH1 Input
- 2B- CH2 Input
- 2C- CH3 Input
- 2D- CH4 Input
- 2E- CH5 Input
- 2F- CH6 Input
- 2G- CH7 Input
- 2H- CH8 Input

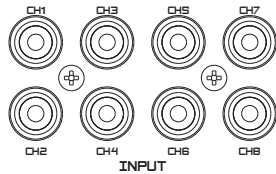

RCA Inputs Example

- Front Left RCA- CH 1
- Front Right RCA- CH 2
- Rear Left RCA- CH 3
- Rear Right RCA- CH 4
- SUB 1 RCA- CH 5
- SUB 2 RCA - CH 6

Speaker Level Example (Signal Summing)

- Left HighFrequency- CH 1 in
- Right High Frequency- CH 2 in
- Left Mid Frequency- CH 3 in
- Right Mid Frequency- CH 4 in
- Left Low Frequency- CH 5 in
- Right Low Frequency- Ch 6 in

3 OPTICAL SIGNAL CONNECTOR-

Each of the Pro-Series DSP products have a single S/PDIF optical connector on them for use to send Hi-resolution digital signal directly to the prodcut in use. Each Pro-Series DSP product is capable of processing audio streams up to 192kHz at 32 bits for the ultimate audiophile experience.

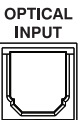

4 BLUETOOTH DONGLE CONNECTOR-

This connection point is for use with the ARC Audio BTD (Bluetooth Dongle) and BTM (Bluetooth Module) in order to allow any of the Pro-Series digital sound processors to accept hi-resolution bluetooth signal from a hi-resolution source Bluetooth source unit. (Sold Separately)

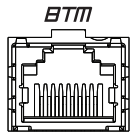

5 DC INPUT JACK-

The PS8-Pro incorporates a DC Input Jack for use with home systems or non 12-Volt DC applications. You will need to purchase a universal power AC/DC power adapter capable of providing at least 3-5 amps of current draw with the proper plug connection (Sold Separately).

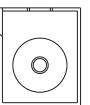

6 "FORCE ON" SWITCH-

The "Force On" labeled switch turns the PR8-Pro on without the need of a remote turn on lead or active vehicle signal source. This is typically used when the PS8-Pro is powered by only +12V and Ground and the main power is switched on or off manually or the PS8-Pro is on a test bench.



7 MAIN POWER/REMOTE/PROFILE PLUG-

- A** +12V" – Main power connection. Connect this lead to the positive side of your vehicles battery using 18-20 AWG OFC power cable. (Always remember to install a fuse within 18" of your vehicles battery with a properly rated fuse).
- B** "GND" – Connect your processor with this terminal to the vehicles ground. The ground wire should be connected directly to the chassis of your vehicle via a 18-20 Gauge OFC ground cable. Find a clear location close to the amplifier and remove all paint and/or sound deadening. Use a #10 or larger screw to secure it. Never use a seat or seat belt bolt for grounding.

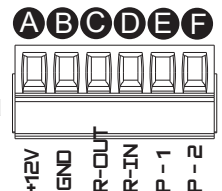

- C** "REM OUT" – Connect your amplifiers Remote Turn-On lead input to this connection point terminal on the PS8-Pro. Always use the processors remote "Turn-On Output" to control and trigger your amplifiers ability to power on or off. (NOTE: The timing of the turn-on out signal is adjustable and can be user defined in the Pro-Series software utility.)
- D** REM IN"- Connect your source units "Remote out" or "Remote turn-on output" lead to the PS8-Pro at this terminal. Making connection to this point from your source unit tells the PS8-Pro when to turn on or off. The timing on this process is customizable from within the Pro-Series DSP software utility..
- E** "PROFILE 1" – Using a toggle switch with a latched ground signal to this point or in combination with "Profile 2" allows users to toggle between the DSP's 4 user defined presets without the need of a controller or PC. This feature can be used by itself or in conjunction with the PSC or LR1 controller.
- F** "PROFILE 2" - Using a toggle switch with a latched ground signal to this point or in combination with "Profile 1" allows users to toggle between the DSP's 4 user defined presets without the need of a controller or PC. This feature can be used by itself or in conjunction with the PSC or LR1 controller.

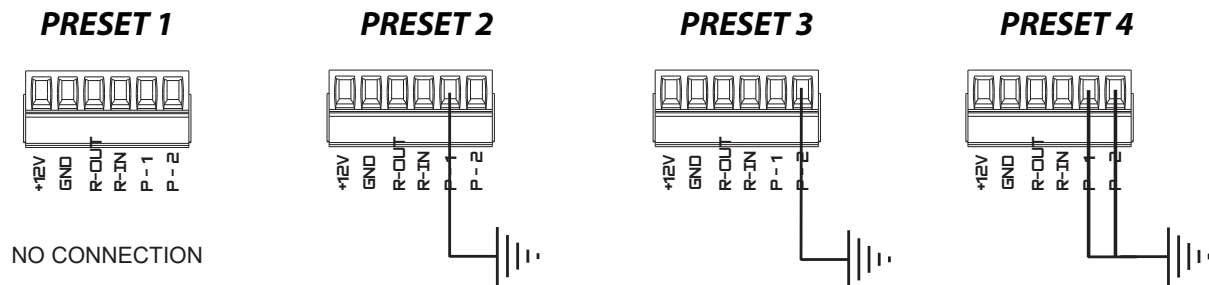

8 AUTO SENSE SELECTION SWITCH-

The PS8-Pro has a selectable microprocessor controlled auto-sense turn on circuit for those applications where there may be no hard wired switched turn on lead available from the source unit. There is two available options on all Pro-Series processors. Users can select from a BTLTD (Bridge Tied Load Detect) Turn-on circuit that offers a significant improvement in reliability over previous designs. Instead of relying on the music to supply enough signal to turn the amplifier on. Robert Zeff's design detects the IC (chip) used in the vast majority of stock head units and amplifiers. It is important to note the DC sense will not always work. Due to the hundreds (or thousands) of different OEM system configurations, no single solution can be 100% successful which is why we also offer traditional signal sensing options "SIG" for activation with normal signal levels passing from your vehicles source. If your system does not reliably switch on and off, look for an alternative turn on source. It is possible to spend many hours trouble shooting an Auto Sense problem. This is time that could be spend enjoying your new audio system.

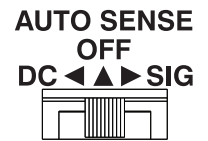

9 PSC CONNECTION PORT-

Each of the Pro-Series DSP products can accomadate direct conneciton from the ARC Audio PSC Controller (Sold Separately). The Controller, when connected to any compatible ARC Audio processor will automatically update its available features and options based on the unit that you are plugingn it into.



10 LR1 REMOTE LEVEL CONNECTION PORT-

This connection port is compatible with the ARC Audio LR1, programmable remote level control (Sold Separately). Connect your LR1 remote level control as a stand alone control knob to this port and assign the desired fucntion of the LR1 via the Pro-Series DSP Software utility. The LR1 can be used in conjunction with the PSC controller or as a stand alone control option.



11 USB CONNECTION PORT-

Connect your Windows 10 based PC to this port to control the DSP features on your DSP equipped product via the ARC Audio Pro-Series DSP Software Utility.

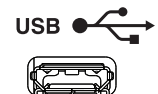

12 AXP PORT-

Experience the best in wireless control of your new Pro-Series processor with the AXP Wi-Fi module (Sold Separately). This accessory module simply plugs into the port and you now have access to all of the tuning features without the need of any USB cables etc.



13 IDL/MAESTRO CONNECTION PORT-

The IDL conneciton port is for direct connection with the Maestro AR Module (Sold Separately) for plug and play integration capabilities on a wide variety of OEM vehicles. For vehicle compatibility please visit http://maestro.idatalink.com/product/product_id/412

